

DIMENSION : 150mmX800mm
 SPECIFICATION : 3mm THK. SSS ROYAL BLUE FIELD ACRYLIC SHEET WITH YELLOW GOLD VERTICAL STRIP
 IN 20mmX150mm 3M VINYL STICKER
 TEXT FONT : 75mm ARIAL BOLD, SSS ROYAL BLUE FIELD NUMBER IN 3M VINYL STICKER CUT-OUT
 WITH WHITE BACKGROUND IN 150mmX150mm 3M VINYL STICKER
 45mm ARIAL BOLD, WHITE LETTERS IN 3M VINYL STICKER CUT-OUT
 35mm ARIAL BOLD, WHITE LETTERS IN 3M VINYL STICKER CUT-OUT
 30mm ARIAL BOLD, WHITE LETTERS IN 3M VINYL STICKER CUT-OUT
 ANCHORAGE : ALUMINUM TUBULAR PIPE WITH CLIP, CEILING MOUNTED (VERIFY ACTUAL SITE CONDITION)

1 COUNTER SIGNAGE
 A-1 A-1 NOT TO SCALE

 SOCIAL SECURITY SYSTEM LUZON CENTRAL 2 DIVISION	PROJECT TITLE:	RECOMMENDING APPROVAL:	APPROVED BY:	CIVIL AND ARCHITECTURAL	SHEET CONTENT:	ALL DRAWINGS MUST BE VERIFIED ON SITE BY THE CONTRACTOR. ALL DISCREPANCIES ARE TO IMMEDIATELY REPORTED TO THE ARCHITECT AND PROJECT MANAGERS. CONTRACTORS ARE TO PREPARE AND SUBMIT SHOP DRAWINGS TO THE ARCHITECT PRIOR TO COMMENCEMENT OF WORKS.	SHEET NO.
	PROPOSED INDOOR SIGNAGE FOR SSS BALIUAG BRANCH LOCATION: AC Building, B.S. Aquino, Tangos, Baliuag, Bulacan	 CHELINA LEA D. NABONG ACTING BRANCH HEAD	GLORIA CORAZON M. ANDRADA VICE PRESIDENT	DRAWN BY: ROLLY P. GONZALES - Bldg. Administrator DESIGNED BY: ROLLY P. GONZALES - Bldg. Administrator REVIEWED BY: - CHECKED BY: -	COUNTER SIGNAGE		

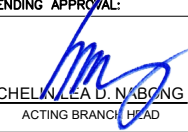
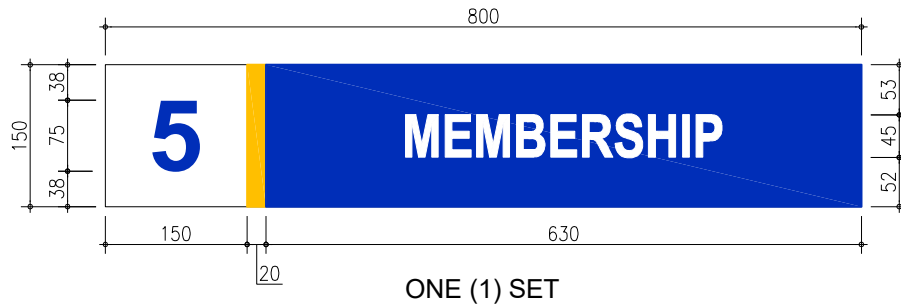

ONE (1) SET

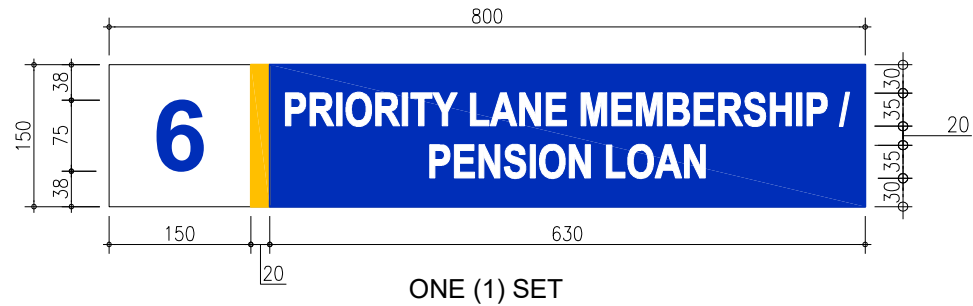

ONE (1) SET

DIMENSION : 150mmX800mm
 SPECIFICATION : 3mm THK. SSS ROYAL BLUE FIELD ACRYLIC SHEET WITH YELLOW GOLD VERTICAL STRIP
 IN 20mmX150mm 3M VINYL STICKER
 TEXT FONT : 75mm ARIAL BOLD, SSS ROYAL BLUE FIELD NUMBER IN VINYL STICKER CUT-OUT
 WITH WHITE BACKGROUND IN 150mmX150mm 3M VINYL STICKER
 45mm ARIAL BOLD, WHITE LETTERS IN 3M VINYL STICKER CUT-OUT
 35mm ARIAL BOLD, WHITE LETTERS IN 3M VINYL STICKER CUT-OUT
 ANCHORAGE : ALUMINUM TUBULAR PIPE WITH CLIP, CEILING MOUNTED (VERIFY ACTUAL SITE CONDITION)

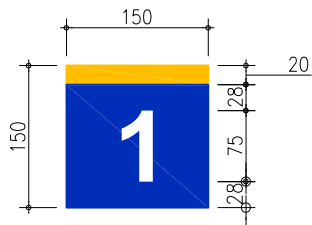

TO

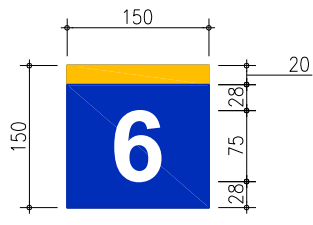

TWO (2) SET

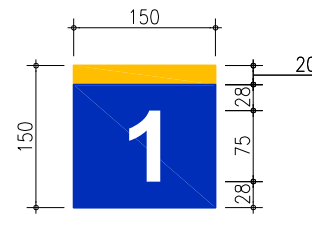

TO

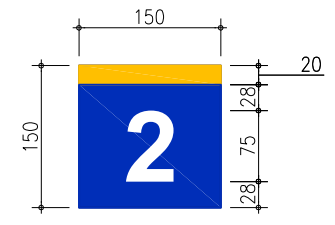

ONE (1) SET

DIMENSION : 150mmX150mm
 SPECIFICATION : 3mm THK. SSS ROYAL BLUE FIELD ACRYLIC SHEET WITH YELLOW GOLD
 HORIZONTAL STRIP IN 20mmX150mm VINYL STICKER
 TEXT FONT : 75mm ARIAL BOLD, WHITE NUMBER IN 2mm THK. ACRYLIC SHEET CUT-OUT
 ANCHORAGE : HEAVY DUTY DOUBLE SIDED TAPE, SIDE PANEL MOUNTED (VERIFY ACTUAL SITE CONDITION)

2 COUNTER SIGNAGE
 A-2 | A-2 NOT TO SCALE



LUZON CENTRAL 2 DIVISION

PROJECT TITLE:
**PROPOSED INDOOR SIGNAGE
 FOR SSS BALIUAG BRANCH**
 LOCATION: AC Building, B.S. Aquino, Tangos, Baliuag, Bulacan

RECOMMENDING APPROVAL:

CHEVIN LEA D. NABONG
 ACTING BRANCH HEAD

APPROVED BY:

GLORIA CORAZON M. ANDRADA
 VICE PRESIDENT

CIVIL AND ARCHITECTURAL
 DRAWN BY:
 ROLLY P. GONZALES - Bldg. Administrator
 DESIGNED BY:
 ROLLY P. GONZALES - Bldg. Administrator
 REVIEWED BY:
 -
 CHECKED BY:
 -

SHEET CONTENT:
 COUNTER SIGNAGE

ALL DRAWINGS MUST BE
 VERIFIED ON SITE BY THE
 CONTRACTOR.
 ALL DISCREPANCIES ARE TO
 IMMEDIATELY REPORTED TO THE
 ARCHITECT AND PROJECT
 MANAGERS.
 CONTRACTORS ARE TO PREPARE
 AND SUBMIT SHOP DRAWINGS TO
 THE ARCHITECT PRIOR TO
 COMMENCEMENT OF WORKS.

SHEET NO.
A-2
 2 | 10

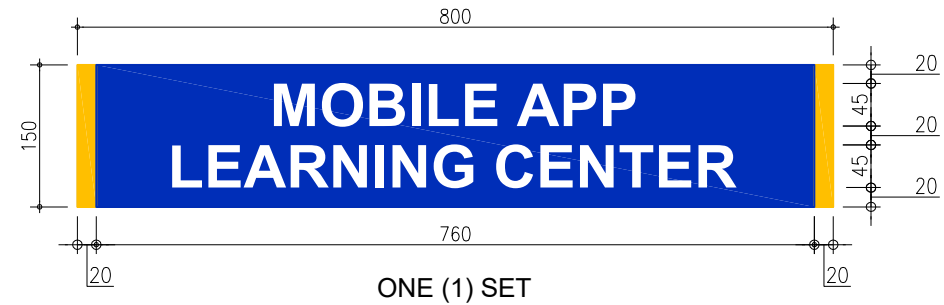
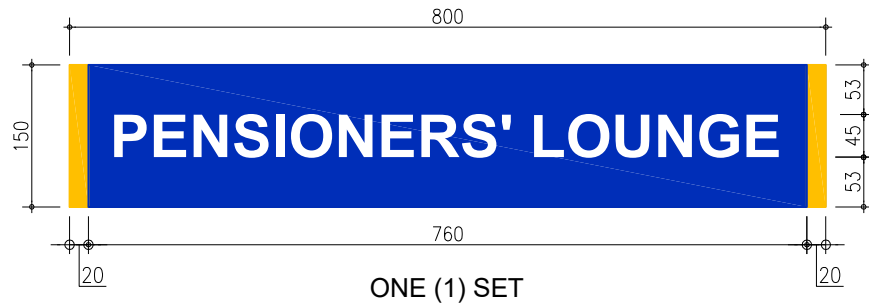
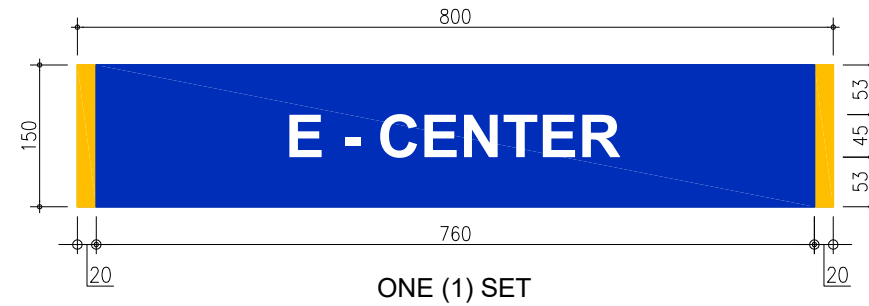
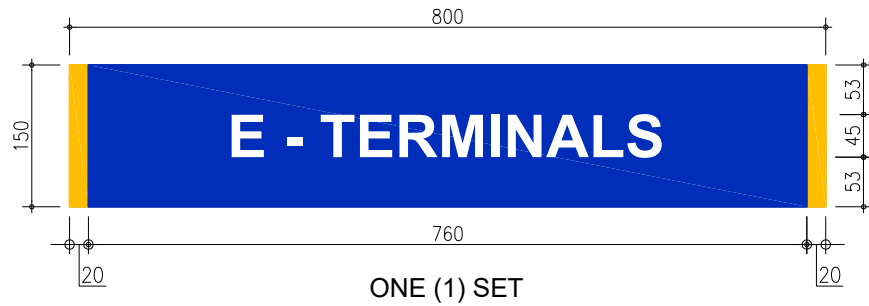

DIMENSION : 150mmX800mm
 SPECIFICATION : BACKGROUND BASE IN 3mm THK. SSS ROYAL BLUE FIELD ACRYLIC SHEET WITH YELLOW GOLD VERTICAL STRIP IN 20mmX150mm 3M VINYL STICKER
 TEXT FONT : 45mm ARIAL BOLD, WHITE LETTERS IN 2mm THK. ACRYLIC SHEET CUT-OUT
 ANCHORAGE : ALUMINUM TUBULAR PIPE WITH CLIP, CEILING MOUNTED (VERIFY ACTUAL SITE CONDITION)

3 INDOOR SIGNAGE
 A-3 | A-3 NOT TO SCALE

<p>SOCIAL SECURITY SYSTEM</p> <p>LUZON CENTRAL 2 DIVISION</p>	<p>PROJECT TITLE:</p> <p>PROPOSED INDOOR SIGNAGE FOR SSS BALIUAG BRANCH</p>	<p>RECOMMENDING APPROVAL:</p> <p><i>[Signature]</i> CHELIN VEA D. NABONG ACTING BRANCH HEAD</p>	<p>APPROVED BY:</p> <p>GLORIA CORAZON M. ANDRADA VICE PRESIDENT</p>	<p>CIVIL AND ARCHITECTURAL</p> <p>DRAWN BY: ROLLY P. GONZALES - Bldg. Administrator DESIGNED BY: ROLLY P. GONZALES - Bldg. Administrator REVIEWED BY: - CHECKED BY: -</p>	<p>SHEET CONTENT:</p> <p>INDOOR SIGNAGE</p>	<p>ALL DRAWINGS MUST BE VERIFIED ON SITE BY THE CONTRACTOR.</p> <p>ALL DISCREPANCIES ARE TO IMMEDIATELY REPORTED TO THE ARCHITECT AND PROJECT MANAGERS.</p> <p>CONTRACTORS ARE TO PREPARE AND SUBMIT SHOP DRAWINGS TO THE ARCHITECT PRIOR TO COMMENCEMENT OF WORKS.</p>	<p>SHEET NO.</p> <p>A-3</p>
	<p>LOCATION: AC Building, B.S. Aquino, Tangos, Baliuag, Bulacan</p>						<p>3 10</p>

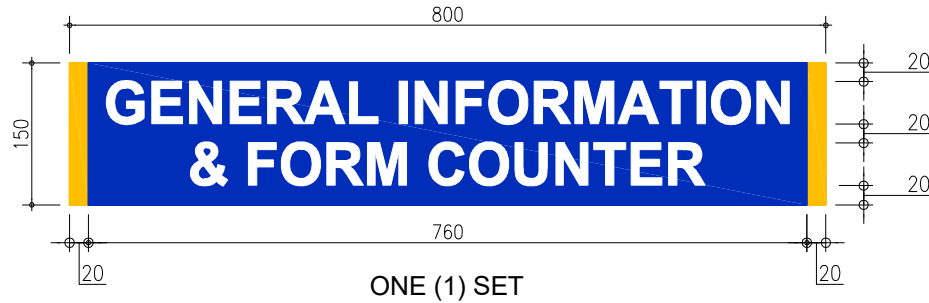
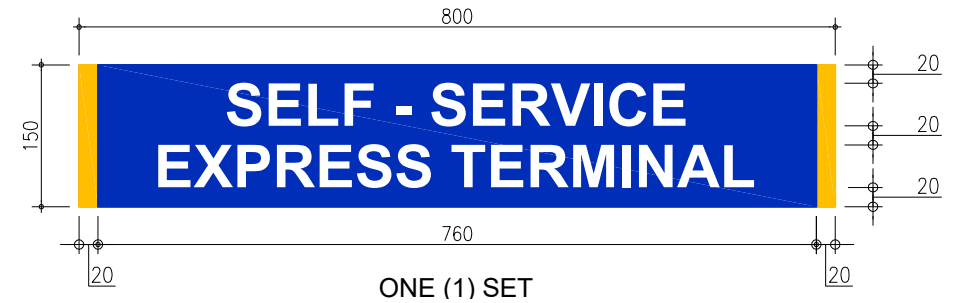
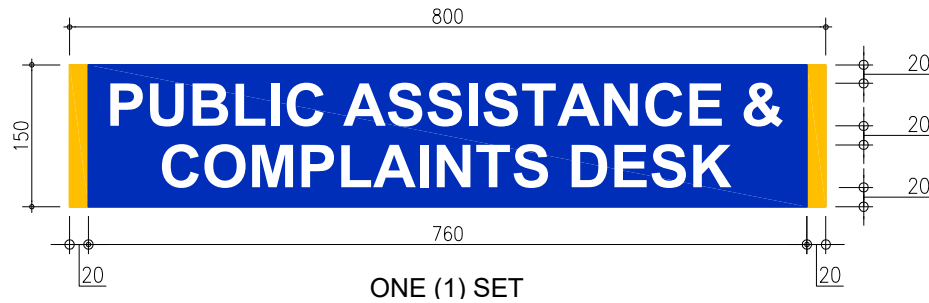

DIMENSION : 150mmX800mm
 SPECIFICATION : BACKGROUND BASE IN 3mm THK. SSS ROYAL BLUE FIELD ACRYLIC SHEET
 WITH YELLOW GOLD VERTICAL STRIP IN 20mmX150mm 3M VINYL STICKER
 TEXT FONT : 45mm ARIAL BOLD, WHITE LETTERS IN 2mm THK. ACRYLIC SHEET CUT-OUT
 ANCHORAGE : ALUMINUM TUBULAR PIPE WITH CLIP, CEILING MOUNTED (VERIFY ACTUAL SITE CONDITION)



DIMENSION : 150mmX800mm
 SPECIFICATION : BACKGROUND BASE 3mm THK. SSS ROYAL BLUE FIELD BACKGROUND ACRYLIC SHEET,
 WITH YELLOW VERTICAL STRIP IN 20mmX150mm VINYL STICKER,
 FIGURES SYMBOL IN 2mm THK. WHITE ACRYLIC SHEET CUT-OUT
 TEXT FONT : 45mm ARIAL BOLD, WHITE LETTERS IN 2mm THK. ACRYLIC SHEET CUT-OUT
 ANCHORAGE : 1/2" Ø STAND-OFF BOLT CHROME FINISH, WALL MOUNTED (VERIFY ACTUAL SITE CONDITION)

4
A-4 | A-4 NOT TO SCALE

INDOOR SIGNAGE

<p>SOCIAL SECURITY SYSTEM</p> <p>LUZON CENTRAL 2 DIVISION</p>	PROJECT TITLE:	RECOMMENDING APPROVAL:	APPROVED BY:	CIVIL AND ARCHITECTURAL	SHEET CONTENT:	<p>ALL DRAWINGS MUST BE VERIFIED ON SITE BY THE CONTRACTOR.</p> <p>ALL DISCREPANCIES ARE TO IMMEDIATELY REPORTED TO THE ARCHITECT AND PROJECT MANAGERS.</p> <p>CONTRACTORS ARE TO PREPARE AND SUBMIT SHOP DRAWINGS TO THE ARCHITECT PRIOR TO COMMENCEMENT OF WORKS.</p>	SHEET NO.
	<p>PROPOSED INDOOR SIGNAGE FOR SSS BALIUAG BRANCH</p> <p>LOCATION: AC Building, B.S. Aquino, Tangos, Baliuag, Bulacan</p>	<p><i>[Signature]</i></p> <p>CHELIN LEA D. NABONG ACTING BRANCH HEAD</p>	<p><i>[Signature]</i></p> <p>GLORIA CORAZON M. ANDRADA VICE PRESIDENT</p>	<p>DRAWN BY: ROLLY P. GONZALES - Bldg. Administrator</p> <p>DESIGNED BY: ROLLY P. GONZALES - Bldg. Administrator</p> <p>REVIEWED BY: -</p> <p>CHECKED BY: -</p>	INDOOR SIGNAGE		<p>A-4</p> <p>4 10</p>

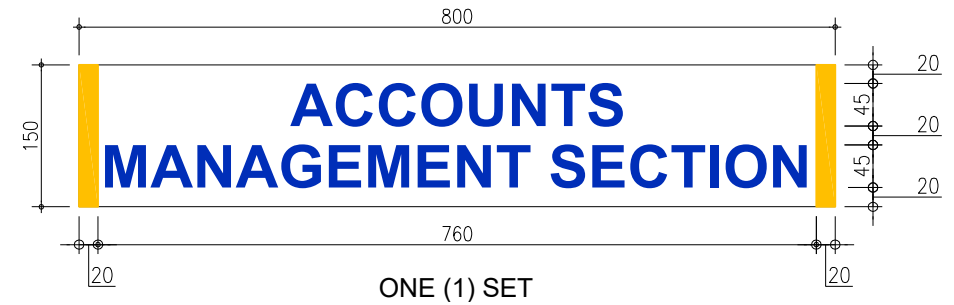
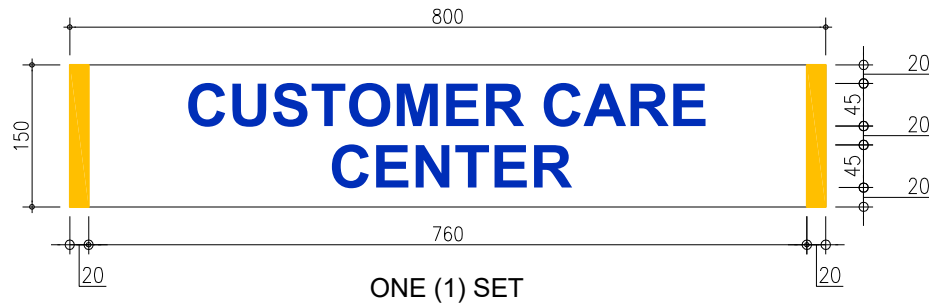
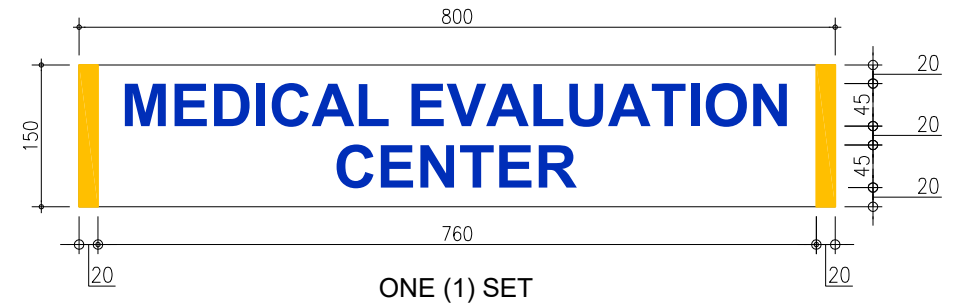
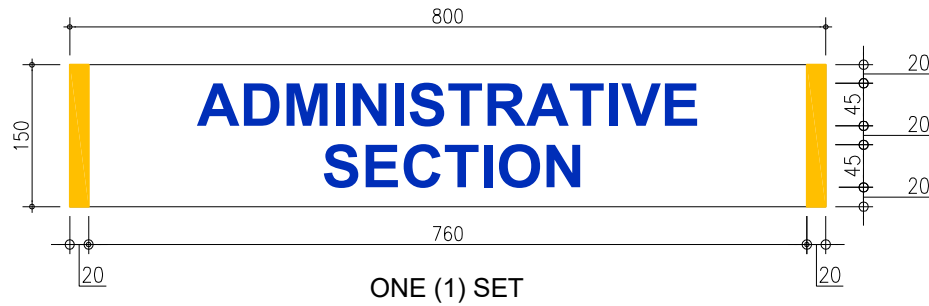

DIMENSION : 150mmX800mm
SPECIFICATION : BACKGROUND BASE IN 3mm THK. WHITE ACRYLIC SHEET WITH YELLOW GOLD VERTICAL STRIP IN 20mmX150mm 3M VINYL STICKER
TEXT FONT : 45mm ARIAL BOLD, SSS ROYAL BLUE FIELD LETTER IN 2mm THK. ACRYLIC SHEET CUT-OUT
ANCHORAGE : ALUMINUM TUBULAR PIPE WITH CLIP, CEILING MOUNTED (VERIFY ACTUAL SITE CONDITION)

5
INDOOR SIGNAGE
 A-5 | A-5 NOT TO SCALE

 SOCIAL SECURITY SYSTEM LUZON CENTRAL 2 DIVISION	PROJECT TITLE: <p style="text-align: center;">PROPOSED INDOOR SIGNAGE FOR SSS BALIUAG BRANCH</p>	RECOMMENDING APPROVAL: <div style="text-align: center;"> <u>CHELIN LEA D. NABONG</u> ACTING BRANCH HEAD </div>	APPROVED BY: <div style="text-align: center;"> <u>GLORIA CORAZON M. ANDRADA</u> VICE PRESIDENT </div>	CIVIL AND ARCHITECTURAL DRAWN BY: ROLLY P. GONZALES - Bldg. Administrator DESIGNED BY: ROLLY P. GONZALES - Bldg. Administrator REVIEWED BY: - CHECKED BY: -	SHEET CONTENT: INDOOR SIGNAGE	ALL DRAWINGS MUST BE VERIFIED ON SITE BY THE CONTRACTOR. ALL DISCREPANCIES ARE TO IMMEDIATELY REPORTED TO THE ARCHITECT AND PROJECT MANAGERS. CONTRACTORS ARE TO PREPARE AND SUBMIT SHOP DRAWINGS TO THE ARCHITECT PRIOR TO COMMENCEMENT OF WORKS.	SHEET NO. <div style="font-size: 24px; font-weight: bold;">A-5</div>
	LOCATION: AC Building, B.S. Aquino, Tangos, Baliuag, Bulacan	<div style="border: 1px solid black; padding: 2px; display: inline-block;"> 5 10 </div>					

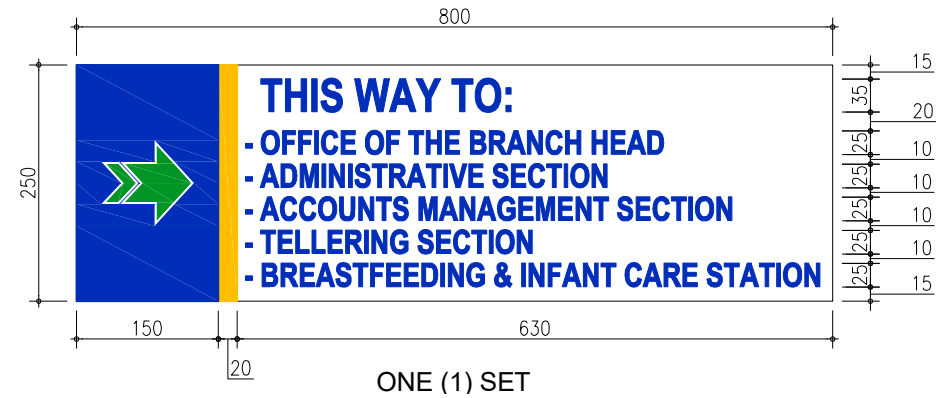
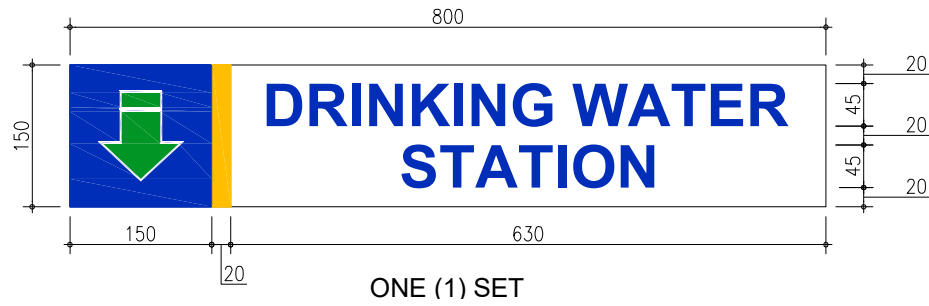

- DIMENSION** : 150mmX800mm / 250mmX800mm
- SPECIFICATION** : 3mm THK. SSS ROYAL BLUE FIELD ACRYLIC SHEET WITH YELLOW GOLD VERTICAL STRIP IN 20mmX150mm 3M VINYL STICKER, FIGURES SYMBOL IN 2mm THK. ACRYLIC SHEET CUT-OUT GREEN ARROW SIGN IN 3M VINYL STICKER CUT-OUT WITH WHITE BACKGROUND IN 150mmX150mm 3M VINYL STICKER
- TEXT FONT** : 45mm ARIAL BOLD, WHITE LETTERS IN 2mm THK. ACRYLIC SHEET CUT-OUT
 35mm ARIAL BOLD, WHITE LETTERS IN 2mm THK. ACRYLIC SHEET CUT-OUT
 25mm ARIAL BOLD, WHITE LETTERS IN 2mm THK. ACRYLIC SHEET CUT-OUT
- ANCHORAGE** : ALUMINUM TUBULAR PIPE WITH CLIP, CEILING MOUNTED (VERIFY ACTUAL SITE CONDITION)

6 **DIRECTIONAL SIGNAGE**
 A-6 | A-6 NOT TO SCALE

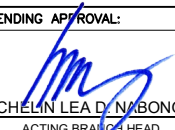
 SOCIAL SECURITY SYSTEM LUZON CENTRAL 2 DIVISION	PROJECT TITLE: PROPOSED INDOOR SIGNAGE FOR SSS BALIUAG BRANCH	RECOMMENDING APPROVAL:  CHELIN LEA D. NABONG ACTING BRANCH HEAD	APPROVED BY: GLORIA CORAZON M. ANDRADA VICE PRESIDENT	CIVIL AND ARCHITECTURAL DRAWN BY: ROLLY P. GONZALES - Bldg. Administrator DESIGNED BY: ROLLY P. GONZALES - Bldg. Administrator REVIEWED BY: - CHECKED BY: -	SHEET CONTENT: DIRECTIONAL SIGNAGE	ALL DRAWINGS MUST BE VERIFIED ON SITE BY THE CONTRACTOR. ALL DISCREPANCIES ARE TO IMMEDIATELY REPORTED TO THE ARCHITECT AND PROJECT MANAGERS. CONTRACTORS ARE TO PREPARE AND SUBMIT SHOP DRAWINGS TO THE ARCHITECT PRIOR TO COMMENCEMENT OF WORKS.	SHEET NO. A-6 6 10
	LOCATION: AC Building, B.S. Aquino, Tangos, Baliuag, Bulacan						



ONE (1) SET

DIMENSION : 150mmX1800mm
 SPECIFICATION : 3mm THK. WHITE ACRYLIC SHEET BACKGROUND
 ANCHORAGE : 1/2" Ø STAND-OFF BOLT, CHROME FINISH (VERIFY ACTUAL SITE CONDITION)

GENDER AND DEVELOPMENT

TEXT FONT : 45mm ARIAL BOLD, COLOR 160, LETTERS IN 2mm THK. ACRYLIC SHEET CUT-OUT
 40mm ARIAL BOLD, COLOR 212 LETTERS IN 2mm THK. ACRYLIC SHEET CUT-OUT

Corner

FONT : 45mm COMMERCIAL SCRIPT BT, YELLOW GOLD, LETTERS IN 2mm THK. ACRYLIC SHEET CUT-OUT
 WIDTH FACTOR : 1.5

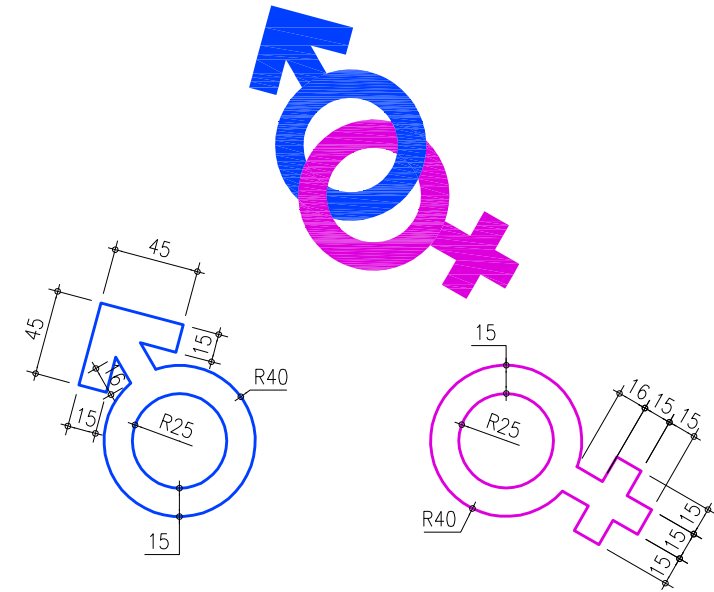

COLOR 160 AND COLOR 212 SYMBOL IN VINYL STICKER CUT-OUT

8
 A-8 | A-8 NOT TO SCALE

<p>SOCIAL SECURITY SYSTEM</p> <p>LUZON CENTRAL 2 DIVISION</p>	PROJECT TITLE:	RECOMMENDING APPROVAL:	APPROVED BY:	CIVIL AND ARCHITECTURAL	SHEET CONTENT:	<p>ALL DRAWINGS MUST BE VERIFIED ON SITE BY THE CONTRACTOR.</p> <p>ALL DISCREPANCIES ARE TO IMMEDIATELY REPORTED TO THE ARCHITECT AND PROJECT MANAGERS.</p> <p>CONTRACTORS ARE TO PREPARE AND SUBMIT SHOP DRAWINGS TO THE ARCHITECT PRIOR TO COMMENCEMENT OF WORKS.</p>	SHEET NO.
	<p>PROPOSED INDOOR SIGNAGE FOR SSS BALIUAG BRANCH</p> <p>LOCATION: AC Building, B.S. Aquino, Tangos, Baliuag, Bulacan</p>	<p><i>[Signature]</i></p> <p>CHELIN LEA D. NABONG ACTING BRANCH HEAD</p>	<p><i>[Signature]</i></p> <p>GLORIA CORAZON M. ANDRADA VICE PRESIDENT</p>	<p>DRAWN BY: ROLLY P. GONZALES - Bldg. Administrator</p> <p>DESIGNED BY: ROLLY P. GONZALES - Bldg. Administrator</p> <p>REVIEWED BY: -</p> <p>CHECKED BY: -</p>	<p>GAD CORNER SIGNAGE</p>		



EIGHT (8) SET

DIMENSION : 100mmX300mm
 SPECIFICATION : 3mm THK. ACRYLIC SHEET IN SSS ROYAL BLUE FIELD BACKGROUND
 FONT : 50mm ARIAL BOLD, WHITE LETTERS IN 3mm THK. ACRYLIC SHEET CUT-OUT
 ANCHORAGE : SUCTION CUP WITH HOOK, GLASS MOUNTED (VERIFY ACTUAL SITE CONDITIC

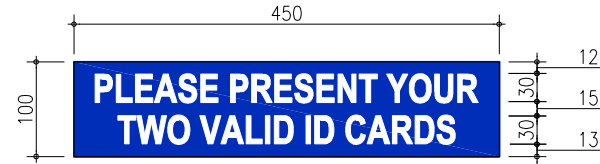

SEVEN (7) SET

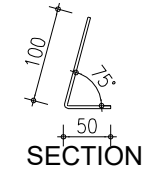

DIMENSION : 100mmX450mmX50mm
 SPECIFICATION : 3mm THK. SSS ROYAL BLUE FIELD BACKGROUND ACRYLIC SHEET
 TEXT FONT : 30mm ARIAL BOLD, WHITE LETTERS IN 3mm THK. ACRYLIC SHEET CUT-OUT
 ANCHORAGE : STANDING DESK PLATE

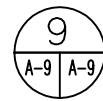

GLASS COUNTER SIGNAGE

NOT TO SCALE

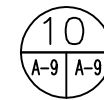

STANDING DESK PLATE SIGNAGE

NOT TO SCALE

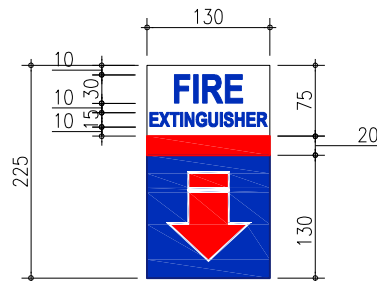

EIGHT (8) SET

DIMENSION : 225mmX130mm
 SPECIFICATION : 3mm THK. WHITE ACRYLIC SHEET WITH HORIZONTAL RED STRIP IN 20mmX130mm 3M VINYL STICKER, ARROW SIGN WITH WHITE OUTLINE IN 3M VINYL STICKER CUT-OUT WITH SSS ROYAL BLUE FIELD BACKGROUND IN 130mmX130mm VINYL STICKER
 TEXT FONT : 30mm ARIAL BOLD, SSS ROYAL BLUE FIELD LETTERS IN 3mm THK. ACRYLIC SHEET CUT-OUT
 15mm ARIAL BOLD, SSS ROYAL BLUE FIELD LETTERS IN 3mm THK. ACRYLIC SHEET CUT-OUT
 ANCHORAGE : HEAVY DUTY DOUBLE SIDED TAPE, WALL MOUNTED (VERIFY ACTUAL SITE CONDITION)

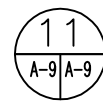

EMERGENCY SIGNAGE

NOT TO SCALE

<p>SOCIAL SECURITY SYSTEM</p> <p>LUZON CENTRAL 2 DIVISION</p>	PROJECT TITLE:	RECOMMENDING APPROVAL:	APPROVED BY:	CIVIL AND ARCHITECTURAL	SHEET CONTENT:	<p>ALL DRAWINGS MUST BE VERIFIED ON SITE BY THE CONTRACTOR.</p> <p>ALL DISCREPANCIES ARE TO IMMEDIATELY REPORTED TO THE ARCHITECT AND PROJECT MANAGERS.</p> <p>CONTRACTORS ARE TO PREPARE AND SUBMIT SHOP DRAWINGS TO THE ARCHITECT PRIOR TO COMMENCEMENT OF WORKS.</p>	SHEET NO.
	<p>PROPOSED INDOOR SIGNAGE FOR SSS BALIUAG BRANCH</p> <p>LOCATION: AC Building, B.S. Aquino, Tangos, Baliuag, Bulacan</p>	<p><i>[Signature]</i></p> <p>CHELIN LEA D. MARONG ACTING BRANCH HEAD</p>	<p><i>[Signature]</i></p> <p>GLORIA CORAZON M. ANDRADA VICE PRESIDENT</p>	<p>DRAWN BY: ROLLY P. GONZALES - Bldg. Administrator</p> <p>DESIGNED BY: ROLLY P. GONZALES - Bldg. Administrator</p> <p>REVIEWED BY: -</p> <p>CHECKED BY: -</p>	<p>GLASS COUNTER SIGNAGE</p> <p>STANDING DESK PLATE SIGNAGE</p> <p>EMERGENCY SIGNAGE</p>		<p>A-9</p>



12
A-10 | A-10

WALL AND DOOR ANCHORAGE

NOT TO SCALE



13
A-10 | A-10

HANGING ANCHORAGE

NOT TO SCALE



**SOCIAL
SECURITY
SYSTEM**

LUZON CENTRAL 2 DIVISION

PROJECT TITLE:

PROPOSED INDOOR SIGNAGE
FOR SSS BALIUAG BRANCH

LOCATION: AC Building, B.S. Aquino, Tangos, Baliuag, Bulacan

RECOMMENDING APPROVAL:

CHELI LLEA D. NABONG
ACTING BRANCH HEAD

APPROVED BY:

GLORIA CORAZON M. ANDRADA
VICE PRESIDENT

CIVIL AND ARCHITECTURAL

DRAWN BY:
ROLLY P. GONZALES - Bldg. Administrator
DESIGNED BY:
ROLLY P. GONZALES - Bldg. Administrator
REVIEWED BY:
-
CHECKED BY:
-

SHEET CONTENT:

WALL AND DOOR ANCHORAGE
HANGING ANCHORAGE

ALL DRAWINGS MUST BE
VERIFIED ON SITE BY THE
CONTRACTOR.

ALL DISCREPANCIES ARE TO
IMMEDIATELY REPORTED TO THE
ARCHITECT AND PROJECT
MANAGERS.

CONTRACTORS ARE TO PREPARE
AND SUBMIT SHOP DRAWINGS TO
THE ARCHITECT PRIOR TO
COMMENCEMENT OF WORKS.

SHEET NO.

A-10

10 | 10